

R3328-DG2N/R3328-DG2NL

Series

User's Manual

NO: G03-R3328-DG2N-F

Revision: 3.0

Release date: October 1, 2019

Trademark:

* Specifications and Information contained in this documentation are furnished for information use only, and are subject to change at any time without notice, and should not be construed as a commitment by manufacturer.

Environmental Protection Announcement

Do not dispose this electronic device into the trash while discarding. To minimize pollution and ensure environment protection of mother earth, please recycle.



TABLE OF CONTENT

ENVIRONMENTAL SAFETY INSTRUCTION.....	iii
USER'S NOTICE	iv
MANUAL REVISION INFORMATION	iv
ITEM CHECKLIST	iv
CHAPTER 1 INTRODUCTION OF THE MOTHERBOARD	
1-1 FEATURE OF MOTHERBOARD.....	1
1-2 SPECIFICATION	2
1-3 PRODUCT DIAGRAM	3
CHAPTER 2 HARDWARE INSTALLATION	
2-1 CONNECTORS	9
2-2 HEADER PIN DEFENITION.....	10



Environmental Safety Instruction

- Avoid the dusty, humidity and temperature extremes. Do not place the product in any area where it may become wet.
- 0 to 40 centigrade is the suitable temperature. (The temperature comes from the request of the chassis and thermal solution)
- Generally speaking, dramatic changes in temperature may lead to contact malfunction and crackles due to constant thermal expansion and contraction from the welding spots' that connect components and PCB. Computer should go through an adaptive phase before it boots when it is moved from a cold environment to a warmer one to avoid condensation phenomenon. These water drops attached on PCB or the surface of the components can bring about phenomena as minor as computer instability resulted from corrosion and oxidation from components and PCB or as major as short circuit that can burn the components. Suggest starting the computer until the temperature goes up.
- The increasing temperature of the capacitor may decrease the life of computer. Using the close case may decrease the life of other device because the higher temperature in the inner of the case.
- Attention to the heat sink when you over-clocking. The higher temperature may decrease the life of the device and burned the capacitor.

USER'S NOTICE

COPYRIGHT OF THIS MANUAL BELONGS TO THE MANUFACTURER. NO PART OF THIS MANUAL, INCLUDING THE PRODUCTS AND SOFTWARE DESCRIBED IN IT MAY BE REPRODUCED, TRANSMITTED OR TRANSLATED INTO ANY LANGUAGE IN ANY FORM OR BY ANY MEANS WITHOUT WRITTEN PERMISSION OF THE MANUFACTURER.

THIS MANUAL CONTAINS ALL INFORMATION REQUIRED TO USE THIS MOTHER-BOARD SERIES AND WE DO ASSURE THIS MANUAL MEETS USER'S REQUIREMENT BUT WILL CHANGE, CORRECT ANY TIME WITHOUT NOTICE. MANUFACTURER PROVIDES THIS MANUAL "AS IS" WITHOUT WARRANTY OF ANY KIND, AND WILL NOT BE LIABLE FOR ANY INDIRECT, SPECIAL, INCIDENTAL OR CONSEQUENTIAL DAMAGES (INCLUDING DAMAGES FOR LOSS OF PROFIT, LOSS OF BUSINESS, LOSS OF USE OF DATA, INTERRUPTION OF BUSINESS AND THE LIKE).

PRODUCTS AND CORPORATE NAMES APPEARING IN THIS MANUAL MAY OR MAY NOT BE REGISTERED TRADEMARKS OR COPYRIGHTS OF THEIR RESPECTIVE COMPANIES, AND THEY ARE USED ONLY FOR IDENTIFICATION OR EXPLANATION AND TO THE OWNER'S BENEFIT, WITHOUT INTENT TO INFRINGE.

Manual Revision Information

Reversion	Revision History	Date
3.0	Third Edition	October 1, 2019

Item Checklist

Motherboard

Chapter 1

Introduction of the Motherboard

1-1 Feature of Motherboard

- Rock chip[®] ARM Cortex A53 RK3328 Quad-core 1.5GHz
- Onboard 2GB 1333MHz DDR3L DRAM
- Onboard 8GB Flash ROM
- Support 1 * Micro-SD (TF) Card Socket (Max to 64GB)
- 1* gigabit external LAN PHY (for ***R3328-DG2N series***)
- 1* gigabit Realtek external LAN PHY & 1 * megabit internal FE PHY(for ***R3328-DG2NL series***)
- 2 * USB 2.0, 1 * OTG,1 * HDMI, 1 * Line-out
- 1* USB 3.0 (for ***R3328-DG2N series***)
- Support 10-bit GPIO
- Support Android 7.1, Linux 4.4 OS

1-2 Specification

Spec	Description
Design	<ul style="list-style-type: none">● 1.8" SBC (85 * 56mm)
CPU	<ul style="list-style-type: none">● Rockchip® ARM Cortex A53 RK3328 Quad-core 1.5GHz SoC <i>* for detailed CPU support information please visit our website</i>
PMU	<ul style="list-style-type: none">● Rockchip® RK805-1
Memory	<ul style="list-style-type: none">● Onboard 2GB 1333MHz DDR3L DRAM● 8GB eMMC Flash ROM
LAN Chip	<ul style="list-style-type: none">● 1* Gigabit Realtek RTL8211E-VB external LAN PHY● 1* Megabit internal FE PHY (<i>* optional for R3328-DG2NL series</i>)
Expansion	<ul style="list-style-type: none">● 1* Micro-SD (TF) Card Socket
External I/O	<ul style="list-style-type: none">● 1* 5V DC-in/ USB OTG combo● 1* HDMI port (3840 x 2160@60Hz)● 1* Audio line-out port● 1* Micro SD Socket
Side I/O	<ul style="list-style-type: none">● 2* USB 2.0 port● 1* 10/100/1000Mbps RJ-45 LAN port● 1* 10/100Mbps RJ-45 LAN port (<i>*Optional for R3328-DG2NL Series</i>)● 1* USB 3.0 port (<i>*Optional for R3328-DG2N Series</i>)
Internal I/O	<ul style="list-style-type: none">● 1* 10-bit GPIO header● 1* UART serial port header● 1* Recover & power switch header

1-3 Product Diagram

IO for R3328-DG2NL Series:

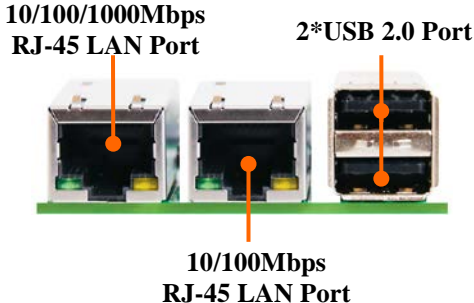

IO for R3328-DG2N Series:

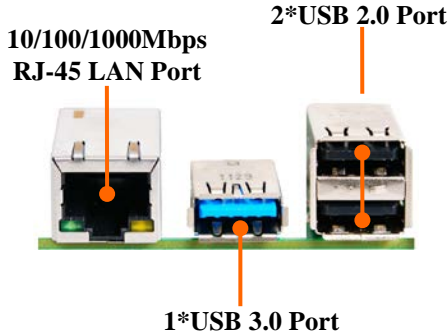

Motherboard Diagram for R3328-DG2NL:

Top View:

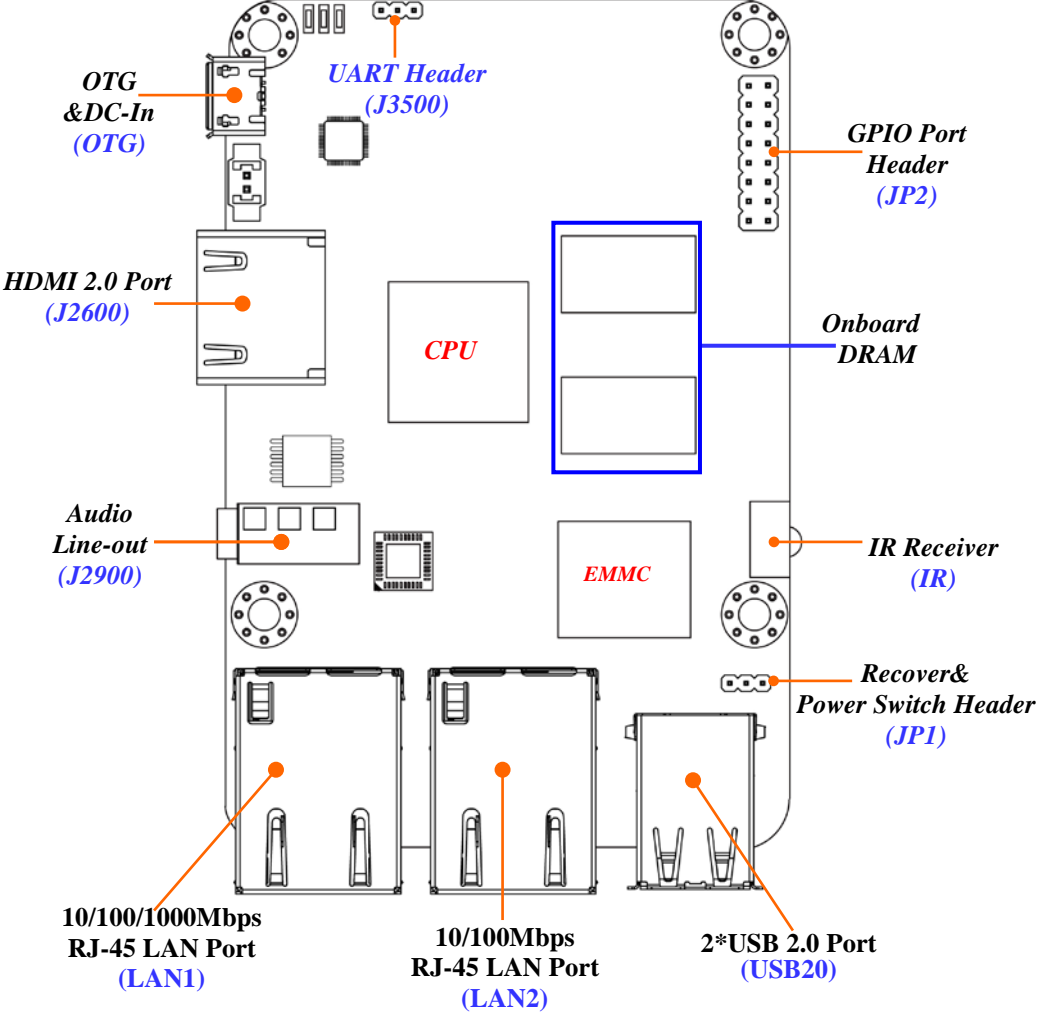

Bottom View:

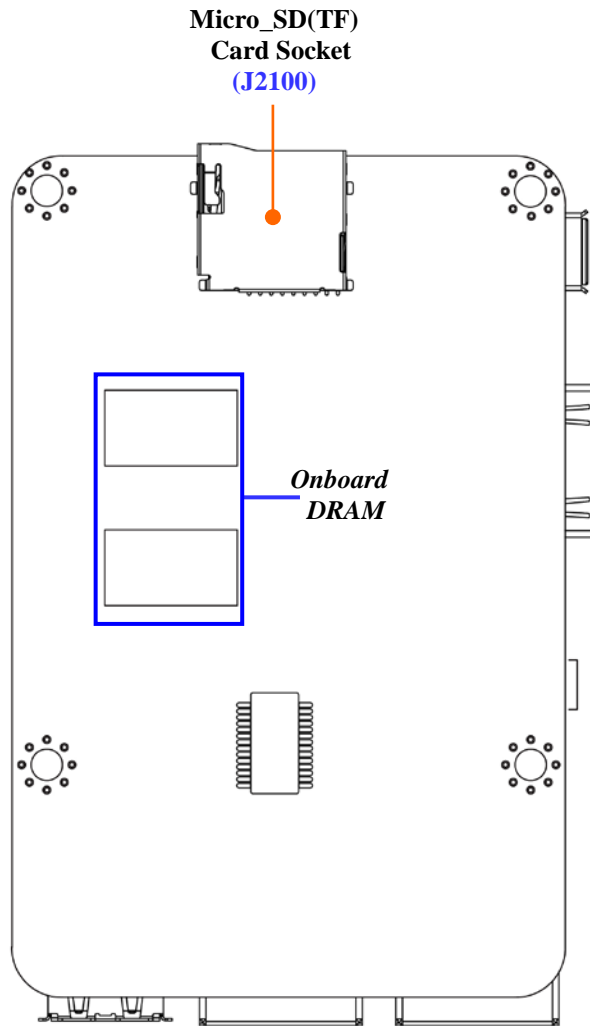

Motherboard Diagram for R328-DG2N:

Top View:

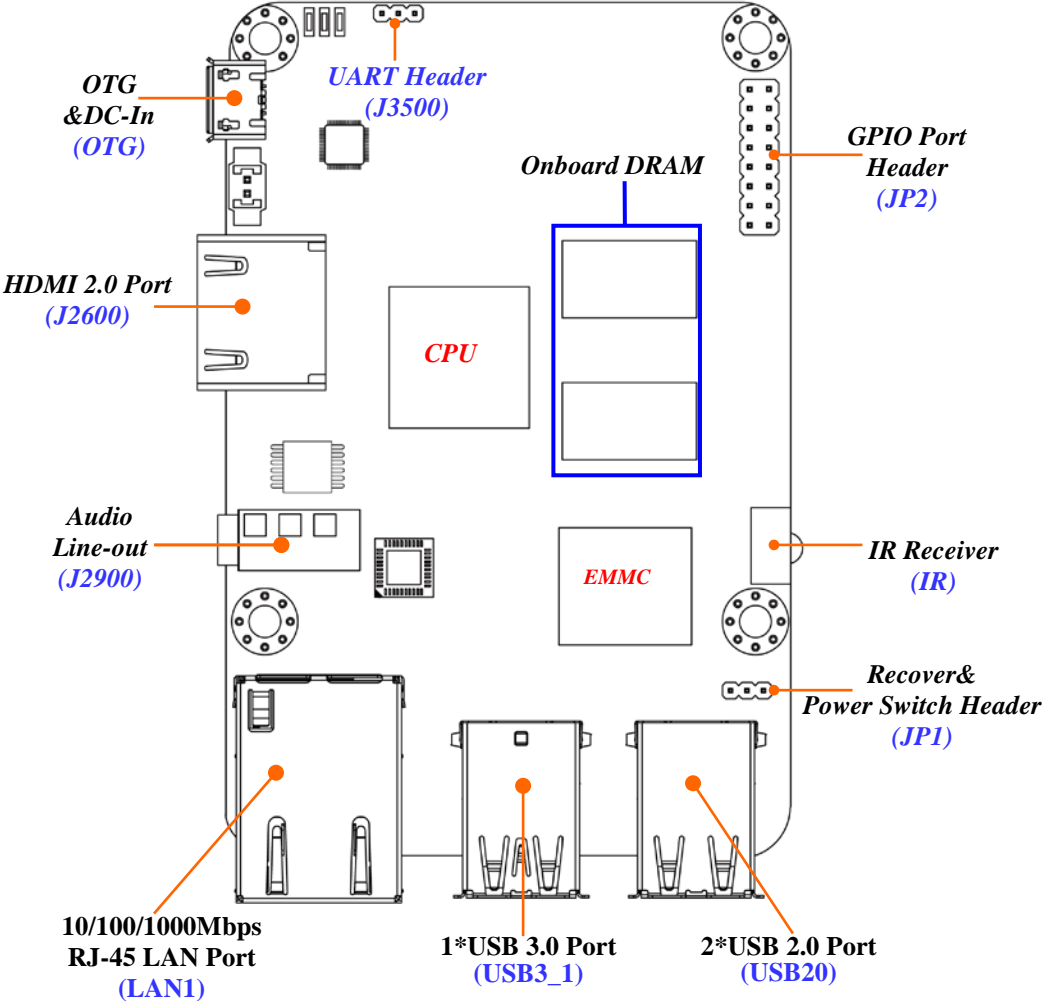

Bottom View:

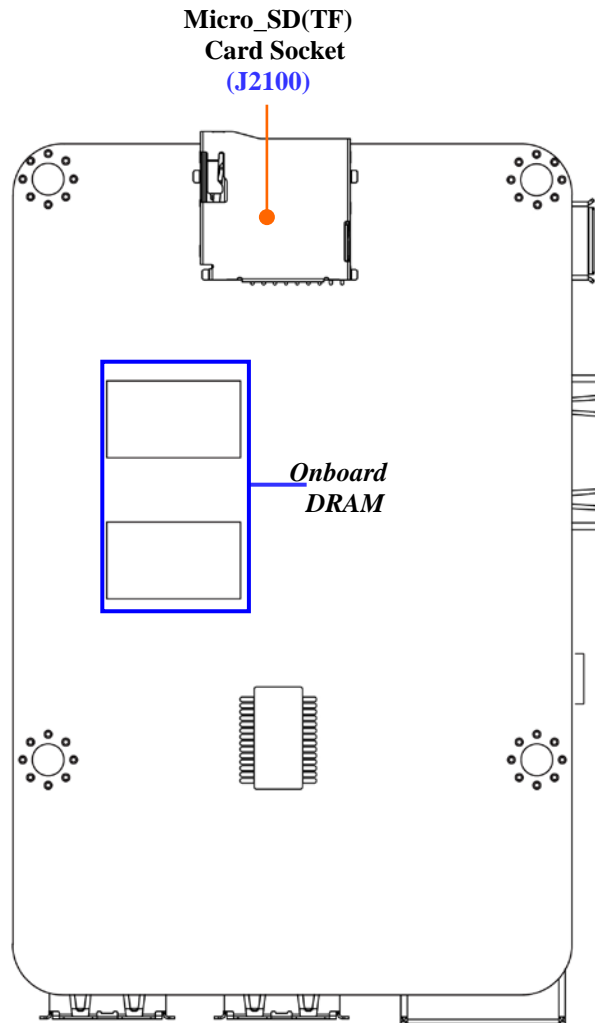

Connectors:

P/N	Name
OTG	5V DC-in & USB OTG connector
J2600	HDMI Port Connector
J2900	Audio Line-out Connector
LAN1	10/100/1000Mbps RJ-45 LAN Port Connector
*LAN2 (optional)	10/100 Mbps RJ-45 LAN Port Connector
*USB3_1 (optional)	USB 3.0 Port
USB20	USB 2.0 Port x2
J2100 (back)	Micro-SD (TF) Card Socket

***Note:** LAN1/USB3_1 is optional to specific model. Please refer to the product of the model you purchased for actual specifications.

Headers:

P/N	Name	Description
J3500	UART Header	3-pin Block
JP1	System Recovery & Power Switch Header	3-pin Block
JP2	10-bit GPIO Header	16-pin Block









Chapter 2

Hardware Installation

2-1 Connectors

(1) External I/O Connectors

** Refer to Page-3.*

<i>Icon</i>	<i>Name</i>	<i>Function</i>
	5V DC-in /USB OTG	<ol style="list-style-type: none">1. For user to connect compatible power supply for the system.2. For user to connect the board with USB OTG cable for software upgrade flash.
	HDMI Port	To connect display device that support HDMI specification.
	Line-out Connector	For user to connect external speaker, earphones, etc to transfer system audio output.
	RJ-45 LAN Port	This connector is standard RJ-45 LAN jack for Network connection.
	*USB 3.0 Port	To connect USB keyboard, mouse or other devices compatible with USB specification.
	USB 2.0 Port	To connect USB keyboard, mouse or other devices compatible with USB specification.
	IR Receiver	To receive remote control signal.
	Macro-SD (TF) Card Socket	For user to insert compatible micro-SD (TF) card into the socket.

2-2 Header Pin Definition

J3500(3-pin): UART Header

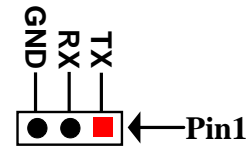
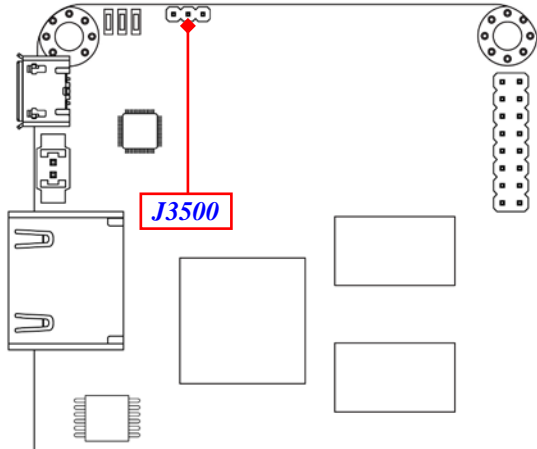

JP1 (3-pin): Recover & Power Switch Header

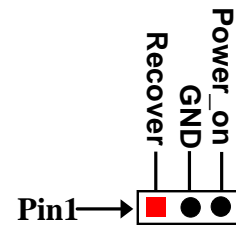
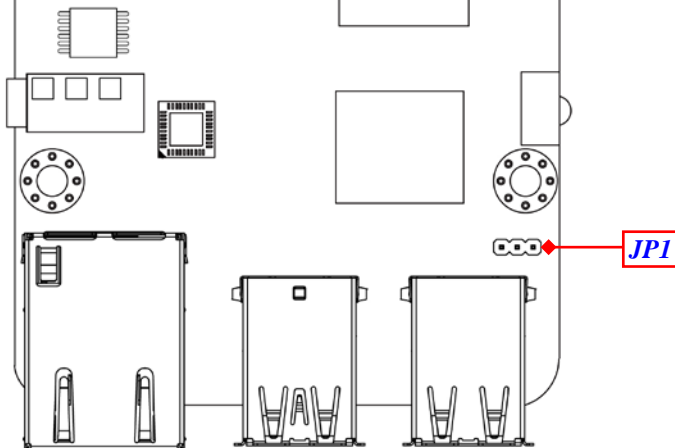

JP1	Recover & Power Switch Header	Function
Pin (1-2):	Recover	For user to flash and update OS.
Pin(2-3)	Power On	Long Press: Force system to shutdown; Short Press: one time for system into Sleep mode, press again to wake up system.

JP2 (16-pin): 10-Bit GPIO Port Header

